

A
SIZE

PROJECTIONS



TOLERANCES UNLESS OTHERWISE SPECIFIED:

PLACES	INCHES	NOTES:
.XX	± .030	ACCEPTABLE BURR ± 10% OF MATERIAL THICKNESS
.XXX	± .015	ALL TOLERANCES ARE NON-CUMULATIVE
.XXXX	± .005	ALL DIMENSIONS APPLY TO PART BEFORE ANY FINISH IS APPLIED
ANGLE	± 3°	

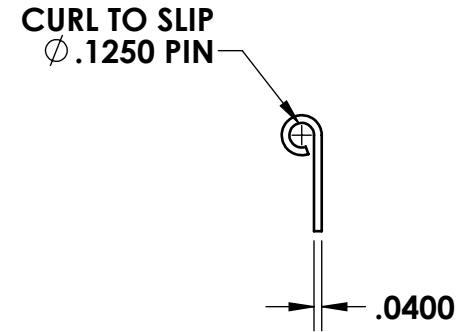
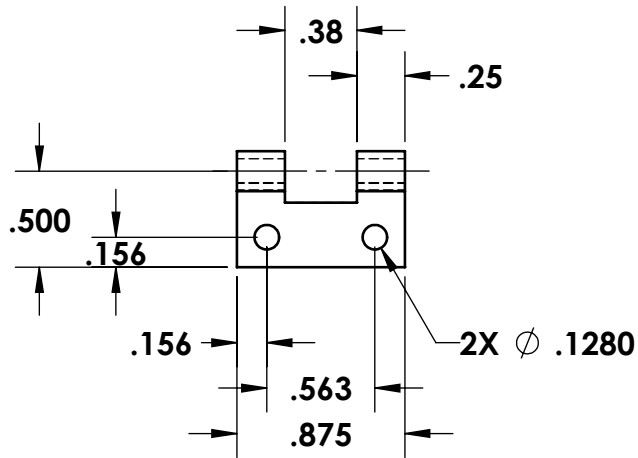

NOTES:
 1. FINISH: 105- BARREL ZINC AND CLEAR TRIVALENT CHROMATE

DWG #: H9292-02BODY		SCALE 1:1	CODE IDENT. # 03007
MATERIAL: PS		FINISH: SEE NOTE	
DR. BY: RAG		CK. BY: JPG	
FAX: 1-631-737-2933		99 RAYNOR AVE.	
EMAIL: info@guden.com		RONKONKOMA, N.Y. 11779	
WEB: www.guden.com		1-800-3-HINGES	

REV.	DESCRIPTION	DATE	APPD
REVISIONS			