

A
SIZE

PROJECTIONS

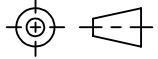

TOLERANCES UNLESS OTHERWISE SPECIFIED:

PLACES	INCHES	NOTES:
.XX	± .030	ACCEPTABLE BURR ± 10% OF MATERIAL THICKNESS
.XXX	± .015	ALL TOLERANCES ARE NON-CUMULATIVE
.XXXX	± .005	ALL DIMENSIONS APPLY TO PART BEFORE ANY FINISH IS APPLIED
ANGLE	± 3°	

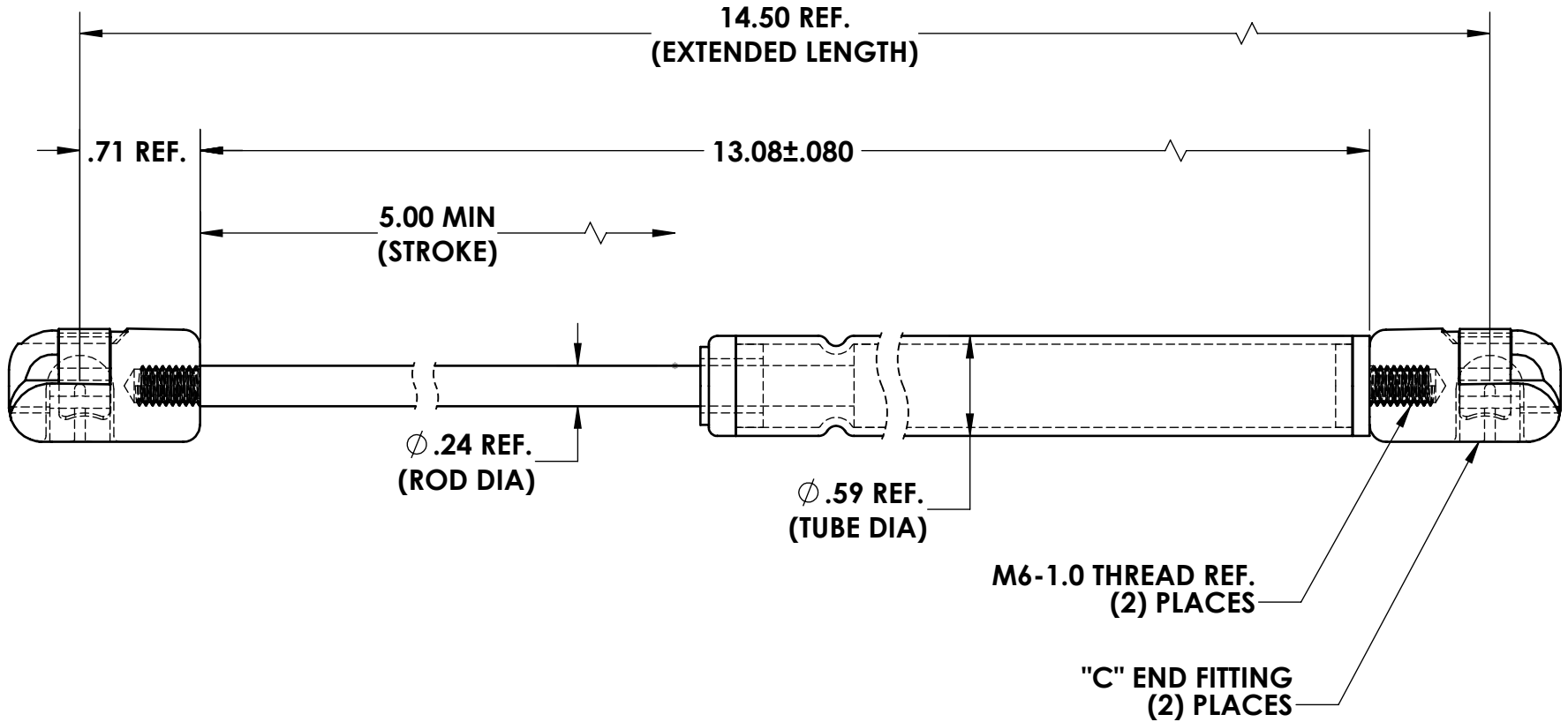

NOTES:

1. FINISH: 00- NO FINISH
2. MATERIAL: TUBE = 316L-ST316
ROD = 303-ST304
3. PART MARK WITH GUDEN P/N AND DATE CODE
4. P1 FORCE = 60 lbs ± 7.0 lbs

DWG #:		SCALE	1:1	CODE IDENT. #
STS45-060-C		DATE	07/28/2017	03007
MATERIAL:	FINISH:	 GUDEN INDUSTRIAL HARDWARE MADE EASY 99 RAYNOR AVE. RONKONKOMA, N.Y. 11779 1-800-3-HINGES		
SEE NOTE	SEE NOTE			
DR. BY: RAG	CK. BY: JPG			
FAX: 1-631-737-2933				
EMAIL: info@guden.com				
WEB: www.guden.com				

REV.	DESCRIPTION	DATE	APPD
	REVISIONS		