

A
SIZE

PROJECTIONS



TOLERANCES UNLESS OTHERWISE SPECIFIED:

PLACES	INCH
.XX	± .030
.XXX	± .015
.XXXX	± .005
ANGLE	3°

NOTE:
ACCEPTABLE BURR ± 10% OF MATERIAL THICKNESS
ALL TOLERANCES ARE NON-CUMULATIVE
ALL DIMENSIONS APPLY TO PART BEFORE ANY FINISH IS APPLIED

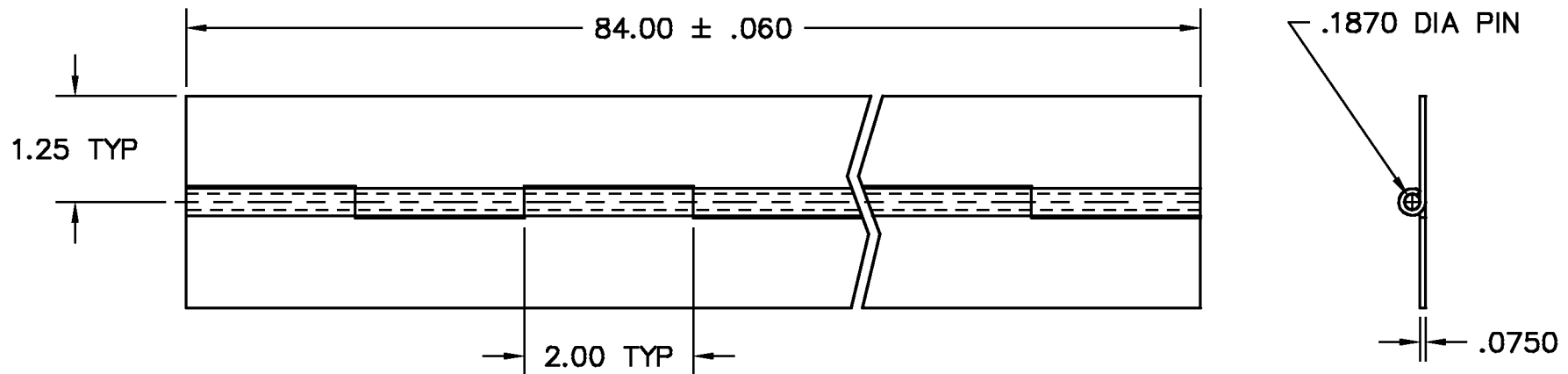

NOTES:
1. FINISH: 00- NO FINISH

DWG PS08070809-84		SCALE 1:2	CODE IDENT. # 03007
MATERIAL PS		FINISH SEE NOTE	
DR. BY RAG		CK. BY CD	
FAX: 1-631-737-2933 EMAIL: info@guden.com WEB: www.guden.com		99 RAYNOR AVE. RONKONKOMA, N.Y. 11779 1-800-3-HINGES	

LTR	DESCRIPTION	DATE	APPD
	REVISION		

