

A
SIZE

PROJECTIONS



TOLERANCES UNLESS OTHERWISE SPECIFIED:

PLACES	INCH
.XX	± .030
.XXX	± .015
.XXXX	± .005
ANGLE	3°

NOTE:
ACCEPTABLE BURR ± 10% OF MATERIAL THICKNESS
ALL TOLERANCES ARE NON-CUMULATIVE
ALL DIMENSIONS APPLY TO PART BEFORE ANY FINISH IS APPLIED

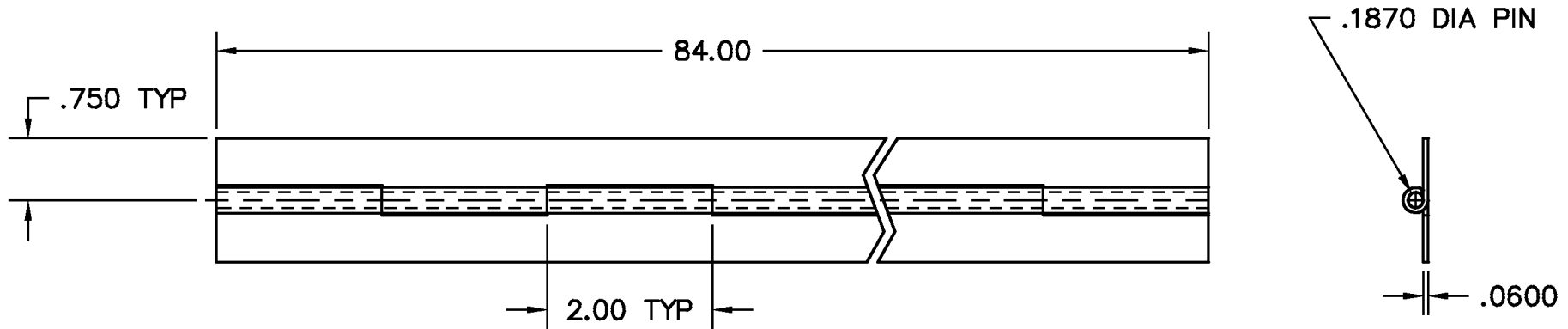

- NOTES:
1. FINISH: 00- NO FINISH
2. MATERIAL: LEAVES = ALUM
PIN = STS

DWG		SCALE	1:2	CODE IDENT. #
AS07070806-84		DATE	08/17/04	03007
MATERIAL	FINISH			
SEE NOTE	SEE NOTE			
DR. BY RAG	CK. BY CD	99 RAYNOR AVE. RONKONKOMA, N.Y. 11779 1-800-3-HINGES		
FAX: 1-631-737-2933				
EMAIL: info@guden.com				
WEB: www.guden.com				

LTR	DESCRIPTION	DATE	APPD
	REVISION		