

A
SIZE

PROJECTIONS



TOLERANCES UNLESS OTHERWISE SPECIFIED:

PLACES	INCH
.XX	± .030
.XXX	± .015
.XXXX	± .005
ANGLE	3°

NOTE:
ACCEPTABLE BURR ± 10% OF MATERIAL THICKNESS
ALL TOLERANCES ARE NON-CUMULATIVE
ALL DIMENSIONS APPLY TO PART BEFORE ANY
FINISH IS APPLIED

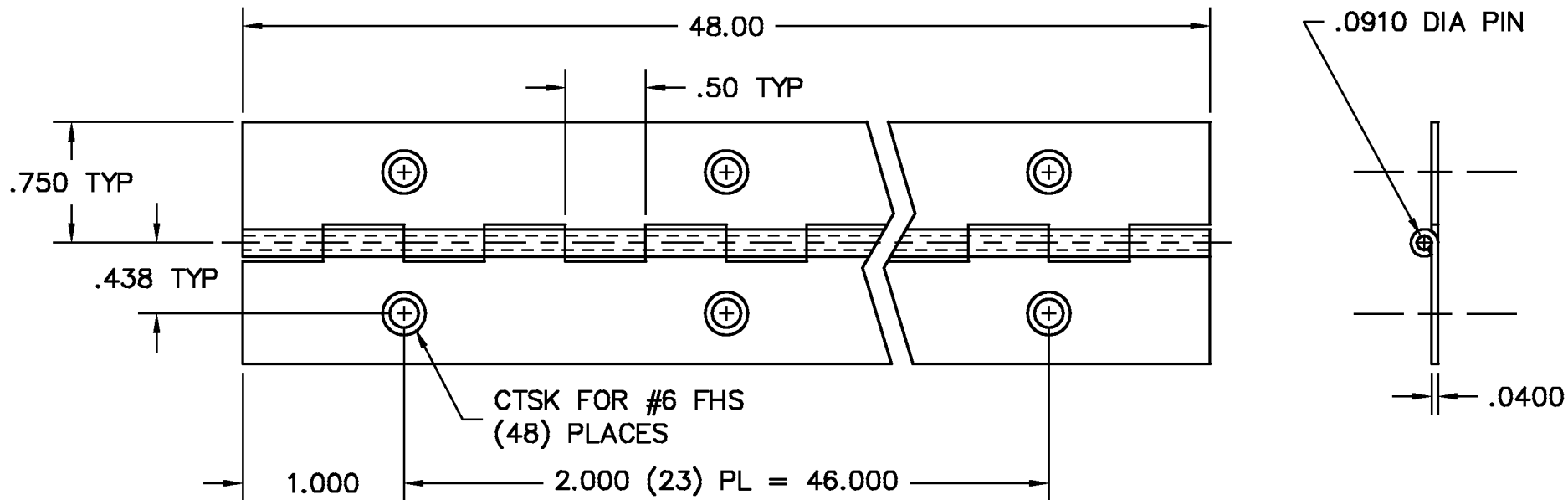

NOTES:
1. FINISH: 12- POLISH - TOPSIDE & KNUCKLE
ALL AROUND

DWG
SP05050406-48

SCALE	1:1	CODE IDENT. #
DATE	06/15/05	03007

MATERIAL
STS

FINISH
SEE NOTE

DR. BY RAG

CK. BY CD

GUDEN
DELIVERING HARDWARE EXCELLENCE

LTR	DESCRIPTION	DATE	APPD
	REVISION		

FAX: 1-631-737-2933
EMAIL: info@guden.com
WEB: www.guden.com

99 RAYNOR AVE.
RONKONKOMA, N.Y. 11779
1-800-3-HINGES