

A  
SIZE

PROJECTIONS



TOLERANCES UNLESS OTHERWISE SPECIFIED:

PLACES	INCH
.XX	± .030
.XXX	± .015
.XXXX	± .005
ANGLE	3°

NOTE:  
ACCEPTABLE BURR ± 10% OF MATERIAL THICKNESS  
ALL TOLERANCES ARE NON-CUMULATIVE  
ALL DIMENSIONS APPLY TO PART BEFORE ANY FINISH IS APPLIED

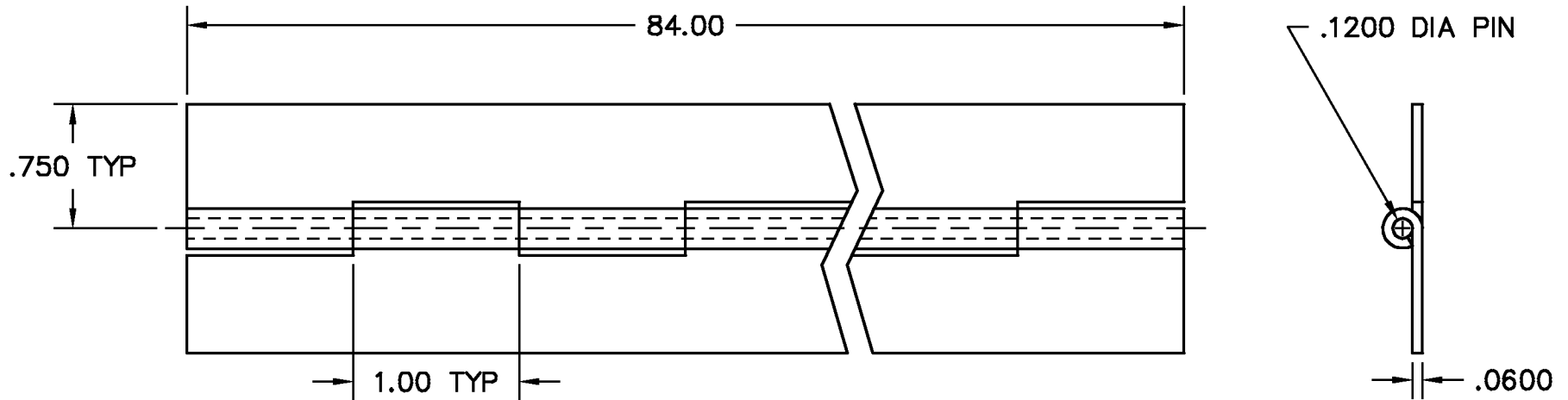

NOTES:  
1. FINISH: 00- NO FINISH

DWG AA07060706-84		SCALE 1:1	CODE IDENT. # 03007
MATERIAL AL5052-H34		FINISH SEE NOTE	
DR. BY RAG		CK. BY CD	
FAX: 1-631-737-2933 EMAIL: info@guden.com WEB: www.guden.com		 99 RAYNOR AVE. RONKONKOMA, N.Y. 11779 1-800-3-HINGES	
LTR			

DESCRIPTION	DATE	APPD
REVISION		