

A
SIZE

PROJECTIONS



TOLERANCES UNLESS OTHERWISE SPECIFIED:

PLACES	INCH	NOTE:
.XX	± .030	ACCEPTABLE BURR ± 10% OF MATERIAL THICKNESS ALL TOLERANCES ARE NON-CUMULATIVE ALL DIMENSIONS APPLY TO PART BEFORE ANY FINISH IS APPLIED
.XXX	± .015	
.XXXX	± .005	
ANGLE	3°	

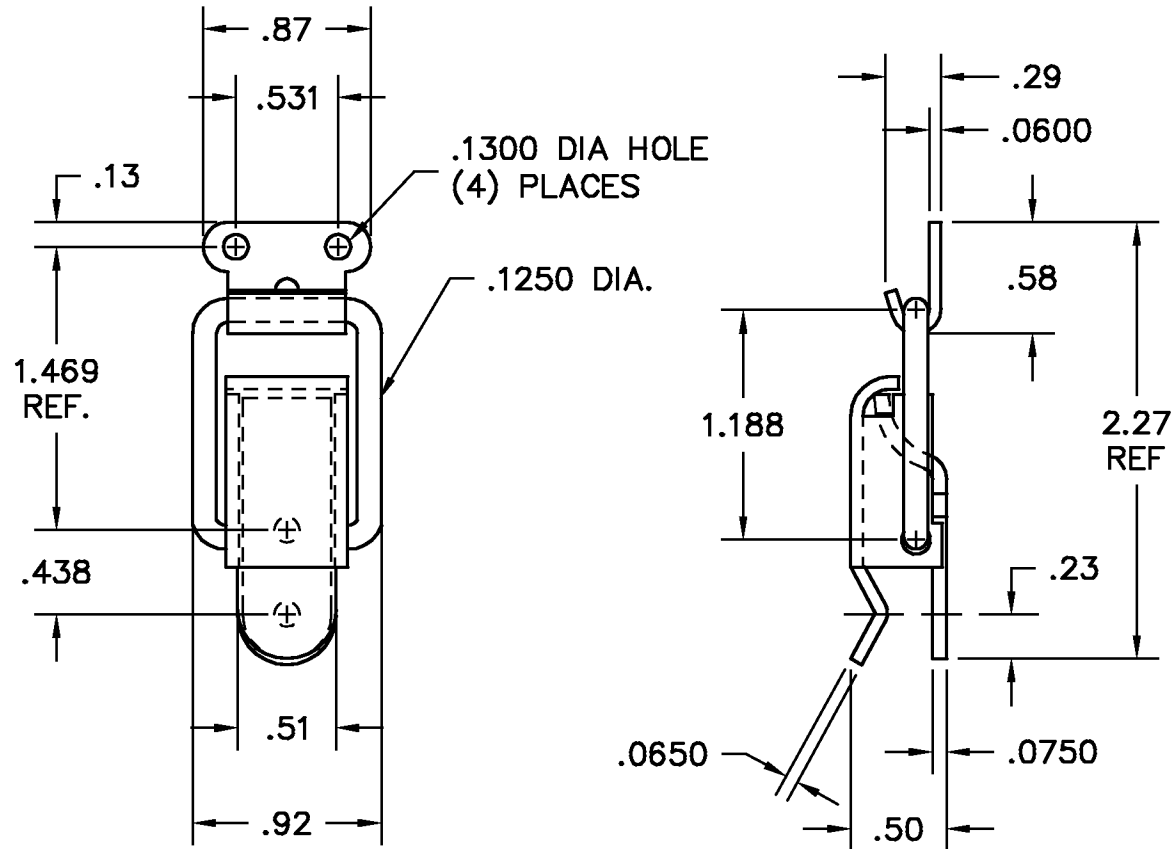

NOTES:
1. FINISH: 90- BARREL ZINC & CLEAR CHROMATE

DWG		SCALE	1:1	CODE IDENT. #
8332-02		DATE	06/22/98	03007
MATERIAL	FINISH			
PS	SEE NOTE			
DR. BY RAG	CK. BY CD	99 RAYNOR AVE. RONKONKOMA, N.Y. 11779 1-800-3-HINGES		
FAX: 1-631-737-2933				
EMAIL: info@guden.com				
WEB: www.guden.com				

LTR	DESCRIPTION	DATE	APPD
	REVISION		